



AUDI

A4 Allroad B9 (8WH, 8WJ)	08/2023 >>
A4 B9 (8W2, 8WC)	08/2023 >>
A4 B9 Avant (8W5, 8WD)	08/2023 >>
A5 (F53, F5P)	08/2023 >>
A5 Convertible (F57, F5E)	08/2023 >>
A5 Sportback (F5A, F5F)	08/2023 >>
E-TRON (GEN)	08/2023 >>
E-TRON Sportback (GEA)	08/2023 >>
Q5 (FYB, FYG)	08/2023 >>
Q5 Sportback (FYT)	08/2023 >>
Q7 (4MB, 4MG)	08/2023 >>
Q7 Van (4MB, 4MG)	08/2023 >>
Q8 (4MN, 4MT)	08/2023 >>
Q8 E-TRON Sportback (GET)	08/2023 >>
Q8 E-TRON SUV (GEG)	08/2023 >>

VOLKSWAGEN

TOUAREG (CR7, RC8) 08/2023 >>



Part No: AU-080-13MU

Electric wiring kit for towbars / 13-pin / 12 Volt / ISO 11446 Product overview

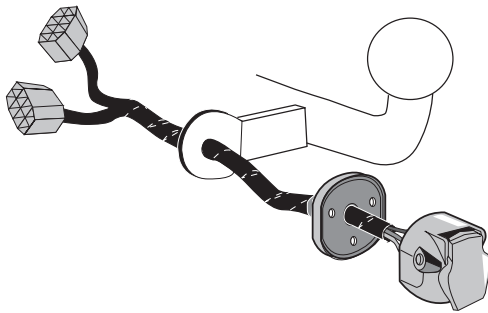

Please note:



This tow bar wiring kit has no influence on the towing vehicle's driver assistance systems. Driver assistance systems will not be influenced or automatically deactivated during trailer operations.

If the vehicle is equipped with the "Remote-Controlled Parking" or "Parking Driver Assistant" function, this function **MUST NOT** be used with a trailer/bike rack attached!



IMPORTANT!

This electric kit has to be installed by a professional workshop or a suitable qualified person.

The installation instructions must have been read and fully understood before the start of any installation. Please contact your wiring kit provider or the hotline shown in the footer should you need assistance!

Make sure the vehicle is approved/homologated by the manufacturer to tow a trailer!

Also please check that there is a definite compatibility between this vehicle and the electric kit!

Following the installation of the electric kit, the fitting instructions should be kept together with the vehicle service document and vehicle handbook. The fitting instructions contain important information relating to the use and function of the towing kit as well as for any diagnostic or activation process, that might have to be repeated in the future (e.g. after the performance of a vehicle software update).

All warranty claims will be forfeited if the electric kit or components contained therein are used incorrectly or modified. If a towing socket adaptor has been used to connect to the trailer or bike rack, this must be removed from the trailer socket once the trailer or bike rack has been disconnected.

If the trailer or bike rack is not equipped with a rear fog lamp, depending on the towing vehicle type, the correct function of the towing kit cannot be guaranteed. In such cases, a rear fog lamp should be retro fitted.

This towing electric kit will not be covered under warranty if any technical or electrical modifications or software updates have been performed by the vehicle manufacturer after the initial commissioning of the kit. That applies especially to modifications or updates which may cause malfunctions in the trailer socket or any other part of the trailer electrical equipment!

Depending on the type of trailer module used in this electric kit, diagnostic interrogation with the vehicle's electrical system may be limited or will not function. The error memory inside the trailer module may not be able to be accessed by vehicle manufacturers diagnostic system.

Error logs relating to the trailer electrical equipment, that may be generated in the vehicle manufacturers diagnostic system as a result of a test procedure, may be due to the incorrect installation of the towing electric kit or the false activation of the trailer module.

We always recommend whenever possible, the following troubleshooting process:

→ An analysis of the vehicle's error memory and possibly clearing of all faults before the start of the installation!

→ Try disconnecting the trailer module from the towing harness and re-start the fault clearing process!

→ If in doubt, limit the time for troubleshooting to a max of 0,5 hours and call our Technical Support Team!

Please follow our instructions carefully and always test the towing electrics using a true lighting board or a specifically designed bulb tester. If an LED tester is used, ensure it is equipped with correct load resistors or malfunctions will occur!

This instruction is subject to changes and we reserve the right to make changes to design, colour etc.

All of the data and illustrations may not be an exact representation but the text contained in this instructions must be observed!

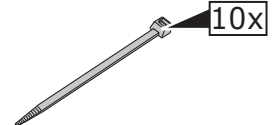
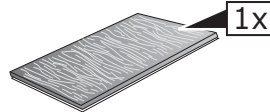
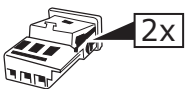
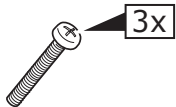
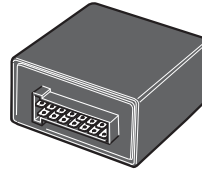
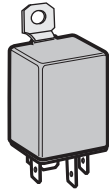
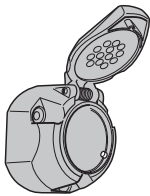
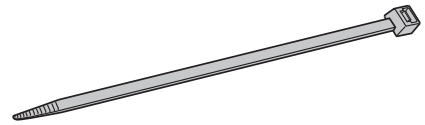
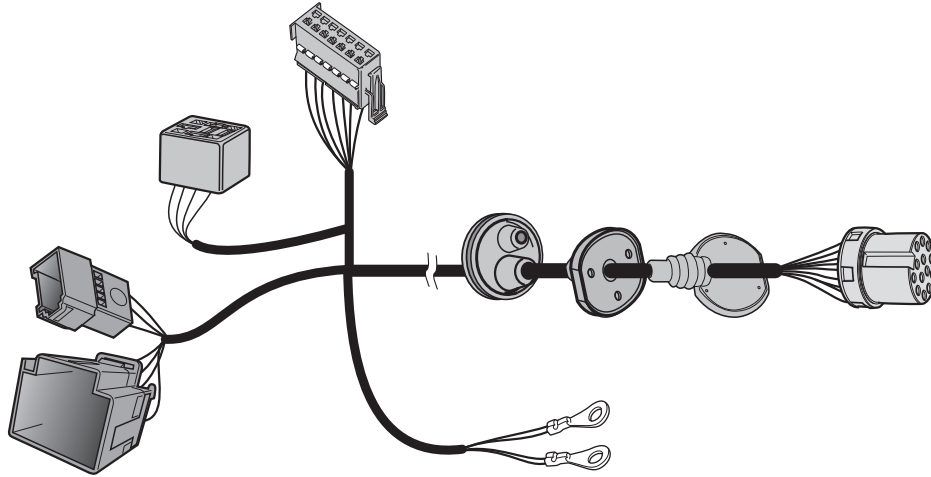
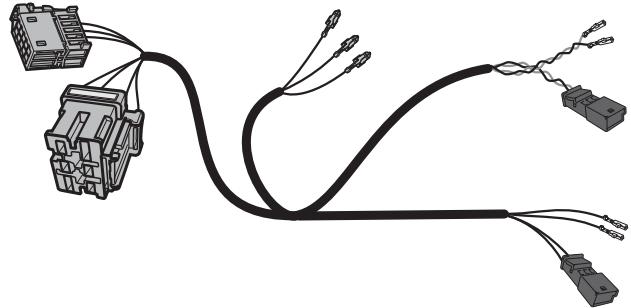
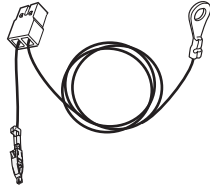
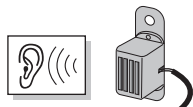

Optional



Consult your supplier.



Trailer Simulator for 7- and 13-pin Sockets

1

Optional

Adapter socket

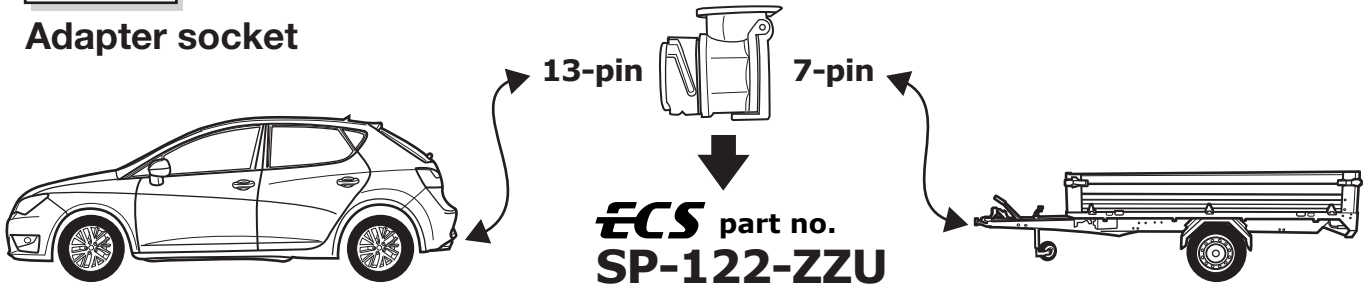

2



Fitting Instructions



Download

from



3

<https://www.ecs-electronicsuk.co.uk/en/au08013mu.html#manualinfo>

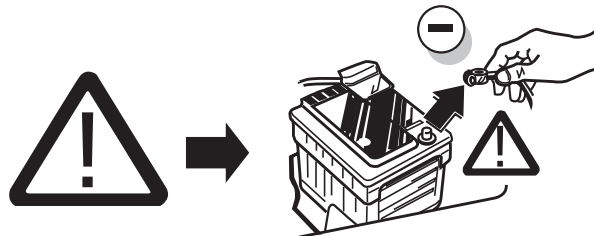

Note: It may be necessary to check if this vehicle has a stored radio code before disconnecting the battery!



4

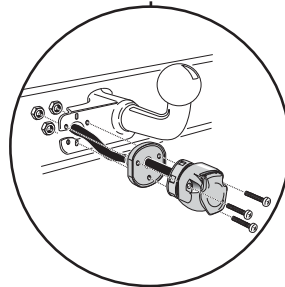
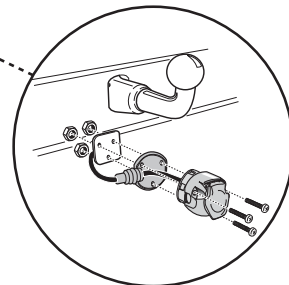
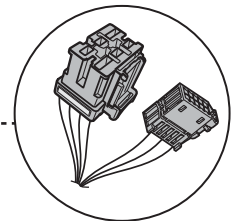
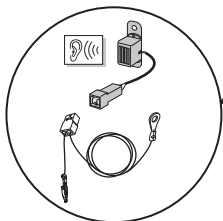
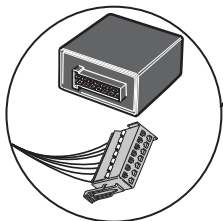
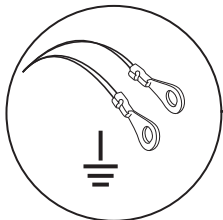
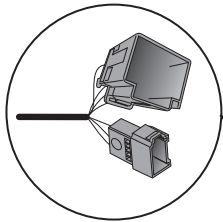
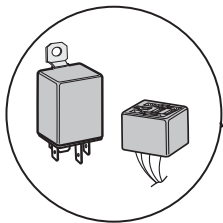
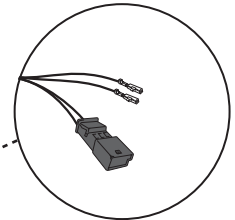
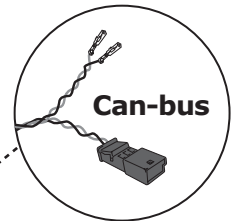
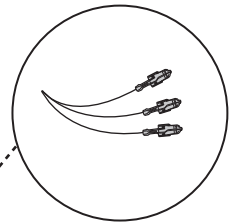
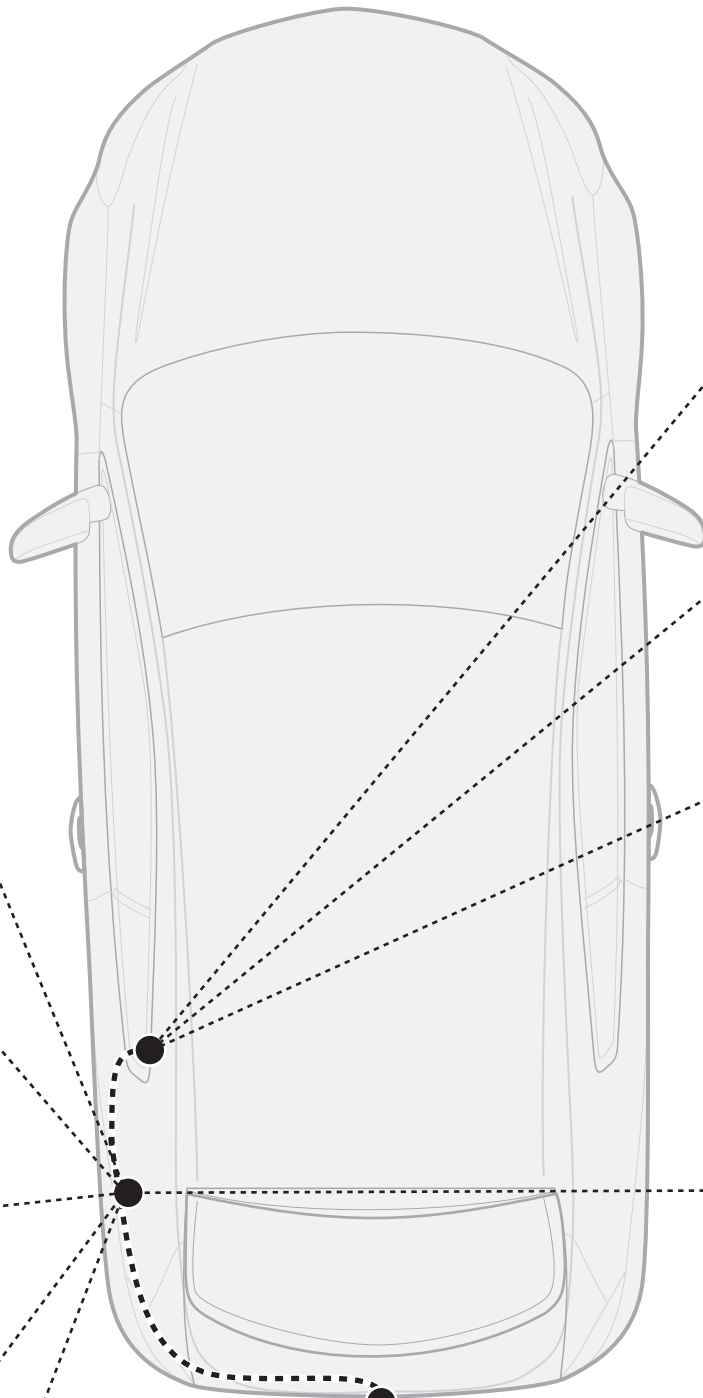

6